

DANISH PATENT AND TRADEMARK OFFICE

## Search for patent documents

TURNING IDEAS INTO ASSETS®

Anne K.S. Jensen  
[ASJ@dkpto.dk](mailto:ASJ@dkpto.dk)

Tone K. Harrit  
[TKH@dkpto.dk](mailto:TKH@dkpto.dk)

Ph. D. Patent course 42799 - 2012 1



DANISH PATENT AND TRADEMARK OFFICE

## Search and Classification

- Search strategy
- How to choose a relevant database
- An example

TURNING IDEAS INTO ASSETS®

Ph. D. Patent course 42799 - 2012 2

  
DANISH PATENT AND TRADEMARK OFFICE

## The benefits from patent documents

- All technical fields
- Early publication 18 month
- Not found in other sources
- Clear technical description
- Easy to find

TURNING IDEAS INTO ASSETS®





Ph. D. Patent course 42799 - 2012 3

  
DANISH PATENT AND TRADEMARK OFFICE

## Patent databases

**Status information**

- Register Plus 
- Inpadoc
- PVS-online (Danish)



**"Access to documents"**

- PVS-online (Danish)
- Register Plus (public file inspection)

**Technical information**

- WPI/ Derwent Innovations Index
- EPO (esp@ce-net)
- USPTO
- JPO
- CHINAPATS 

TURNING IDEAS INTO ASSETS®

Ph. D. Patent course 42799 - 2012 4



DANISH PATENT AND TRADEMARK OFFICE

TURNING IDEAS INTO ASSETS®

2114515

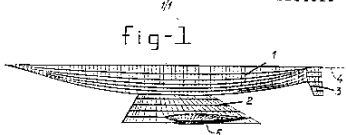

fig-1

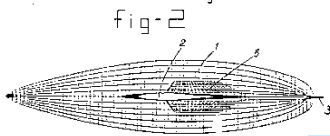

fig-2

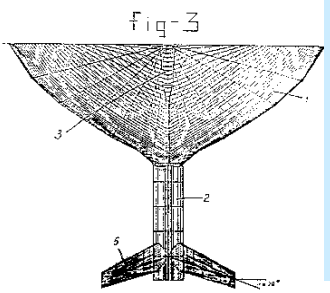



fig-3

**Example**  
Special keel design, used at prestigious Americas Cup in Australia in 1984.

**Sailing yacht**

Patent number:	GB2114515
Publication date:	1983-08-24
Inventor:	LEXCEN BENJAMIN
Patent owner:	NORPORT PTY LTD
Application number:	GB19820019066 19820701
Priority:	NL19820000457 19820205
IPC Class:	B63B1/16
ECLA Class:	B63B3/38
Family members:	AU8566882, FR2521093, IT1151991, NL8200457, SE8204022

Ph. D. Patent course 42799 - 2012 5



DANISH PATENT AND TRADEMARK OFFICE

## Search strategy

<p>If you know a company name either a competitor or a firm</p> <p style="text-align: center;">↓</p> <p>Search for Company name</p> <p>Find words and patent classes</p> <hr/> <p>Find: IPC-Classes, ECLA-classes, US-Classes</p> <p>Find : Characteristic words Synonyms</p> <p>Use articles, technical dictionaries, google etc.</p>	<p>"Quick and dirty"</p> <p style="text-align: center;">↓</p> <p>Search with few words that describe the invention</p> <p>Find words and patent classes</p> <hr/> <p>(Classification manual)</p> <p>(Classification manual)</p> <p>(Not words that describes the class)</p>
--	---

Ph. D. Patent course 42799 - 2012 6

  
DANISH PATENT AND TRADEMARK OFFICE

## Choose a database

<b>TURNING IDEAS INTO ASSETS®</b>	<p><a href="#">USPTO</a></p> <p>Truncating is possible Only US documents</p> <p>Both abstract and full-text(1976-) search</p> <p>Cited patents Citing patents</p>	<p><a href="#">Esp@cenet</a></p> <p>"worldwide" patent search</p> <p>Truncating is possible US,EP,WO,JP, GB, DE, FR IPC/ECLA classes</p> <p>Only search in abstracts No full text search (text/PDF) No citation search</p>
-----------------------------------	---	--

---

Ph. D. Patent course 42799 - 2012 7

  
DANISH PATENT AND TRADEMARK OFFICE

## Choose a database, continued

<b>TURNING IDEAS INTO ASSETS®</b>	<p><a href="#">Derwent Innovations Index</a></p> <p>More Countries (besides US, EP, WO, JP)</p> <p>Truncation of words IPC classes, Derwent classes Only Derwent abstracts</p> <p>Cited patents Citing patents</p>	<p><a href="#">JPO:</a></p> <p>Only JP No truncation IPC-classes, FI/F-terms Only abstracts</p> <p>Status information Machine translation (1993-)</p>
-----------------------------------	--	---

---

**Evaluate the found patents and if they are not sufficient**

**TRY AGAIN**

---

Ph. D. Patent course 42799 - 2012 8

  
DANISH PATENT AND TRADEMARK OFFICE

## Classification

- IPC Classification
- Classification of patent applications
- Other class systems

TURNING IDEAS INTO ASSETS®

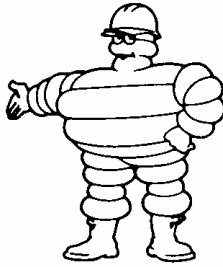

Ph. D. Patent course 42799 - 2012 9

  
DANISH PATENT AND TRADEMARK OFFICE

## IPC or International cl.

International Patent Classification

**8. version: 2012.01 –**

...

(8. version: 2006.01)

7. version: 2000 -

6. version: 1994 -

5. version: 1989 -

4. version: 1984 -

3. version: 1979 -

2. version: 1974 -

1. version: 1968 -

TURNING IDEAS INTO ASSETS®

Ph. D. Patent course 42799 - 2012 10

TURNING IDEAS INTO ASSETS®

(19) 日本国特許庁 (J P)      (12) 公開特許公報 (A)      (11) 特許出願公開番号  
**特開平11-202758**  
(43) 公開日 平成11年(1999) 7月30日



**PATENT AND TRADEMARK OFFICE**

<p>(5) Int.Cl.<sup>4</sup>      識別記号      F I</p> <p>G 0 9 B 11/10           G 0 9 B 11/10      G</p> <p>G 0 6 F 3/00      6 5 1      G 0 6 F 3/00      6 5 1 A</p> <p>G 0 6 T 1/00           15/02      A</p>	<p style="text-align: center;">審査請求 未請求 請求項の数28 O L (全 12 頁)</p> <table border="1" style="width: 100%; border-collapse: collapse;"> <tr> <td style="width: 50%; vertical-align: top;"> <p>(21) 出願番号      特願平10-227425</p> <p>(22) 出願日      平成10年(1998) 8月11日</p> <p>(31) 優先権主張番号      0 8 / 9 6 1 , 7 8 0</p> <p>(32) 優先日      1997年10月31日</p> <p>(33) 優先権主張国      米国 (U S)</p> </td> <td style="width: 50%; vertical-align: top;"> <p>(71) 出願人      598108571                      フォト ファンタジー、インコーポレーテッド                      Foto Fantasy, Inc.                      アメリカ合衆国 ニューハンプシャー州                      03087 ウィンドハム レンジ ロード                      57</p> <p>(72) 発明者      イェフィム マツサースキー                      アメリカ合衆国 マサチューセッツ州                      02101 ニュートン ウィンチェスター                      ストリート 302</p> <p>(74) 代理人      弁護士 西教 圭一郎 (外 3 名)</p> <p style="text-align: right;">最終頁に続く</p> </td> </tr> </table>	<p>(21) 出願番号      特願平10-227425</p> <p>(22) 出願日      平成10年(1998) 8月11日</p> <p>(31) 優先権主張番号      0 8 / 9 6 1 , 7 8 0</p> <p>(32) 優先日      1997年10月31日</p> <p>(33) 優先権主張国      米国 (U S)</p>	<p>(71) 出願人      598108571                      フォト ファンタジー、インコーポレーテッド                      Foto Fantasy, Inc.                      アメリカ合衆国 ニューハンプシャー州                      03087 ウィンドハム レンジ ロード                      57</p> <p>(72) 発明者      イェフィム マツサースキー                      アメリカ合衆国 マサチューセッツ州                      02101 ニュートン ウィンチェスター                      ストリート 302</p> <p>(74) 代理人      弁護士 西教 圭一郎 (外 3 名)</p> <p style="text-align: right;">最終頁に続く</p>
<p>(21) 出願番号      特願平10-227425</p> <p>(22) 出願日      平成10年(1998) 8月11日</p> <p>(31) 優先権主張番号      0 8 / 9 6 1 , 7 8 0</p> <p>(32) 優先日      1997年10月31日</p> <p>(33) 優先権主張国      米国 (U S)</p>	<p>(71) 出願人      598108571                      フォト ファンタジー、インコーポレーテッド                      Foto Fantasy, Inc.                      アメリカ合衆国 ニューハンプシャー州                      03087 ウィンドハム レンジ ロード                      57</p> <p>(72) 発明者      イェフィム マツサースキー                      アメリカ合衆国 マサチューセッツ州                      02101 ニュートン ウィンチェスター                      ストリート 302</p> <p>(74) 代理人      弁護士 西教 圭一郎 (外 3 名)</p> <p style="text-align: right;">最終頁に続く</p>		

(54) 【発明の名称】      画家の描画または彫刻の作成をシミュレーションする方法、およびその方法を達成するための装置

(57) 【要約】  
 【課題】      芸術的価値を有する、画家の描画または彫画の作成をシミュレーションする方法および装置を提供する。  
 【解決手段】      電子的に記憶された画像からの、画家の疑似描画または彫画画像 (mock artist's drawing or painting image) の作成を、モニタ上でシミュレーションする方法において、電子的に記憶された画像を、疑似画像を作成することのできるコンピュータ命令に翻訳する段階と、疑似画像の描画または彫画のシミュレーションを行うアイコンを生成し、モニタ上に表示する段階と、前記命令を使用して、前記アイコンをモニタを横切って移動させる段階とを含み、疑似画像は、前記アイコンが移動するに従って順次的に作成され、画家が疑似画像を作成する過程のシミュレーションを行うことを特徴とする方法および本発明の方法を達成する装置。



11

TURNING IDEAS INTO ASSETS®



**DANISH PATENT AND TRADEMARK OFFICE**

<p><b>A Human Necessities</b>                      E.g.: Agriculture, foodstuffs, health, hygiene, sports</p> <p><b>B Performing Operations, Transportation</b>                      E.g.: Mixing, shaping, vehicles, trains, airplanes</p> <p><b>C Chemistry, Metallurgy</b>                      E.g.: Chemical compounds, cements, fertilisers</p> <p><b>D Textiles, Paper</b>                      E.g.: Yarns, sewing, weaving, paper production</p>	<p><b>E Fixed Constructions</b>                      E.g.: Building, railways, bridges, sewerage, water supply, mining</p> <p><b>F Mechanical Engineering, Lightning, Heating, Weapons, Blasting</b>                      E.g.: Combustion engines, pumps, ventilation, lamps</p> <p><b>G Physics</b>                      E.g.: Measuring, computing, photo, music, optic</p> <p><b>H Electricity</b>                      E.g.: Generators, cables, semi conductors, telecommunication</p>
---	--

Ph. D. Patent course 42799 - 2012

12



DANISH PATENT AND TRADEMARK OFFICE

## IPC classification

		Number
B	Section	8
B 64	Class	118
B 64 C	Subclass	624
B 64 C 1/00	Group	
B 64 C 1/02	Subgroup	67.000

TURNING IDEAS INTO ASSETS®

Ph. D. Patent course 42799 - 2012 13



DANISH PATENT AND TRADEMARK OFFICE

## IPC classification

B	PERFORMING OPERATIONS; TRANSPORTING	Section
<u>B64</u>	AIRCRAFT; AVIATION; COSMONAUTICS	Class
<u>B64C</u>	AEROPLANES; HELICOPTERS (air-cushion vehicles <a href="#">B60V</a> )	Subclass
<u>B64C25/00</u>	Alighting gear (air-cushion alighting gear <a href="#">B60V3/08</a> )	Main group
<u>B64C25/02</u>	• Undercarriages	• Subgroup
<u>B64C25/08</u>	• • non-fixed, e.g. jettisonable	• • Subgroup.
<u>B64C25/10</u>	• • • retractable, foldable, or the like	3 • Subgroup.
<u>B64C25/18</u>	• • • • Operating mechanisms	4 • Subgroup
<u>B64C25/26</u>	• • • • • Control or locking systems therefor	5 • Subgroup
<u>B64C25/30</u>	• • • • • • emergency actuated	6 • Subgroup

TURNING IDEAS INTO ASSETS®

Ph. D. Patent course 42799 - 2012 14

**DANISH PATENT AND TRADEMARK OFFICE**

IPC	Definitions	Illustrations	RCL	Catchwords	Help	Options
B64C 25/00	Landing gear (air-cushion alighting gear B60V 3/08)					
B64C 25/02	Undercarriages					
B64C 25/04	Arrangement or disposition on aircraft					
B64C 25/06	fixed					
B64C 25/08	non-fixed, e.g. jettisonable					
B64C 25/10	retractable, foldable, or the like					
B64C 25/12	snowways					
B64C 25/14	fore-and-aft					
B64C 25/16	Fairings movable in conjunction with undercarriage elements					
B64C 25/18	Operating mechanisms					
B64C 25/20	mechanical					
B64C 25/22	fluid					
B64C 25/24	electric					
B64C 25/26	Control or locking systems therefor					
B64C 25/28	with indicating or warning devices					
B64C 25/30	emergency actuated					
B64C 25/32	characterised by elements which contact the ground or similar surface (arrestor hooks B64C 25/68)					
B64C 25/34	wheeled type, e.g. multi-wheeled bogies					
B64C 25/36	Arrangements or adaptations of wheels, tyres, or axles in general (construction of wheels or axles B60B; construction of tyres in general B60C)					
B64C 25/38	endless-track type					
B64C 25/40	the elements being rotated before touch-down					
B64C 25/42	Arrangement or adaptation of brakes (the ground braking force being regulated, at least in part, by a speed condition, e.g. acceleration or deceleration of the aircraft)					
B64C 25/44	Actuating mechanisms					
B64C 25/46	Brake regulators for preventing skidding or aircraft somersaulting					
B64C 25/48	differentially operated for steering purposes					
B64C 25/50	Steerable undercarriages; Shimmy-damping (steering devices applicable to land vehicles B62D)					
B64C 25/52	Skis or runners					
B64C 25/54	Floats					
B64C 25/56	Inflatable (connection of valves to inflatable elastic bodies B60C 29/00)					
B64C 25/58	Arrangements or adaptations of shock-absorbers or springs (shimmy-dampers B64C 25/50; vehicle suspension arrangements in general B60G; shock-absorbers B60D)					
B64C 25/60	Oleo legs					
B64C 25/62	Spring shock-absorbers; Springs					
B64C 25/64	using rubber or like elements					
B64C 25/66	Convertible alighting gear; Combinations of different kinds of ground or like engaging elements					
B64C 25/68	Arrestor hooks (arresting gear, e.g. on aircraft carriers, B64F)					
Aircraft kinds or components not otherwise provided for						
B64C 27/00	Rotorcraft; Rotors peculiar thereto (alighting gear B64C 25/00)					

*Note: Brackets in the original image group B64C 25/04-25/10 as 'Two-dot groups', B64C 25/12-25/18 as 'Four-dot groups', and B64C 25/28-25/30 as 'Six-dot groups'. A large bracket on the right groups all these items under 'Landing gear & undercarriages'.*

**DANISH PATENT AND TRADEMARK OFFICE**

### Criteria for classification

TURNING IDEAS INTO ASSETS®

- Generally try to find the best place as far down the hierarchy as possible
- Preferences are given in the notes (1/18 takes precedence)
- Last class rule

E.g. Hand cultivator

Section: A

Class: 01

Subclass: B

Main group: 1/00

Sub group: 1/14

The class is: A 01 B 1/14



Ph. D. Patent course 42799 - 2012 16



DANISH PATENT AND TRADEMARK OFFICE

## Other class systems

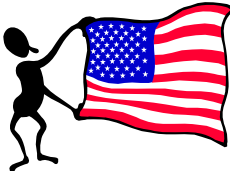
- ECLA
- US classification
- Japanese F-terms
- German classification
- Dutch classification







Ph. D. Patent course 42799 - 2012 17

DANISH PATENT AND TRADEMARK OFFICE

## US classification



**Class + subclass**

**CCC/SSS.SSS**



**Examples:**

<b>123/5</b>	<b>123/400</b>	<b>D12/60</b>	<b>23/2.41</b>
<b>2/DIG.40</b>	<b>560/901</b>	<b>100/45P</b>	<b>5/48.1AR</b>

Ph. D. Patent course 42799 - 2012 18

DANISH PATENT AND TRADEMARK OFFICE

### Search profile: Vacuum cleaner attachment

Search words: Manufacturers: Time limitations?

- nozzle
- paint
- remove
- vacuum
- suction
- scraper
- brush

Hoover  
Electrolux,  
Nilfisk ?

IPC classes:  
B44D 3/16  
A47L 7/00  
B08B 5/04

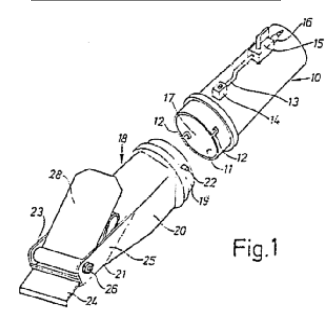
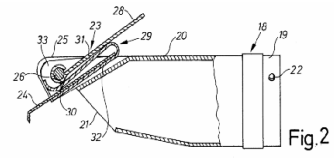
Ph. D. Patent course 42799 - 2012

DANISH PATENT AND TRADEMARK OFFICE

### Search profile:

Key elements:	Remove paint	Vacuum cleaner nozzle
<b>Classes:</b> IPC-classes ECLA-classes US-classes (Remember all classes in the hierarchy)	B44D 3/16	A47L 7/00 B08B 5/04
<b>Search words:</b> Remember: Synonyms Truncations GB/US spelling differences	Paint, ink, dye Remove, scrape etc.	nozzle vacuum suction scraper
<b>Other:</b> Company, inventor, Cited documents	Electrolux, Hoover, Nilfisk	

Ph. D. Patent course 42799 - 2012 20

Advanced Search

1. Database

Select patent database: Worldwide

2. Search terms

Enter keywords in English

Keyword(s) in title: plastic and bicycle  
 Keyword(s) in title or abstract: vacuum and suction, hair

Publication number: WO200814520  
 Application number: DE19971031696  
 Priority number: WO1995US15925

Publication date: yyyymmdd  
 Applicant(s): Institut Pasteur  
 Inventor(s): Smith

European Classification (ECLA): B44D3/16 F03G7/10  
 International Patent Classification (IPC): B44D3/16 H03M1/12

SEARCH CLEAR

IPC/ECLA-class for the first key element  
 B44D 3/16  
 Has the title:  
*Implements or apparatus for removing dry paint from surfaces, e.g. by scraping, by burning (chemical paint-removers C09D 9/00)*  
 We combine with relevant words from the second key element:  
 suction, vacuum

Search → Results

RESULT LIST

2 results found in the Worldwide database for:  
 vacuum and suction in the title or abstract AND B44D3/16 as the European Classification AND B44D3/16 as the IPC classification

Sort by: Upload Date | Sort order: Descending | Sort

1. PEELING OF PROTECTIVE FILM

Inventor	Applicant	EC	IPC	Publication info	Priority Date
★ JUNAKOSHI KEIGO NOMURA KOUZOU (+2)	NITTO ELECTRIC IND CO	B29C63/00A2 B44D3/16	B29C63/00 B44D3/16 C09J5/00 (+5)	JP59174677 (A) 1984-10-03 JP63022235 (B) 1988-05-11 JP1476892 (C) 1989-01-27	1983-03-24

2. Improvements relating to Vacuum Apparatus for Removing Paint and Varnish.

Inventor	Applicant	EC	IPC	Publication info	Priority Date
★ WILSON JOHN MACNAULL [US]	WILSON JOHN MACNAULL [US]	B44D3/16	B44D3/16	GB191204159 (A) 1912-11-07	1912-02-10

Accessibility | Legal notice | Terms of use | Last updated: 5.12.2011 | Worldwide Database | 5.7.31; 92p

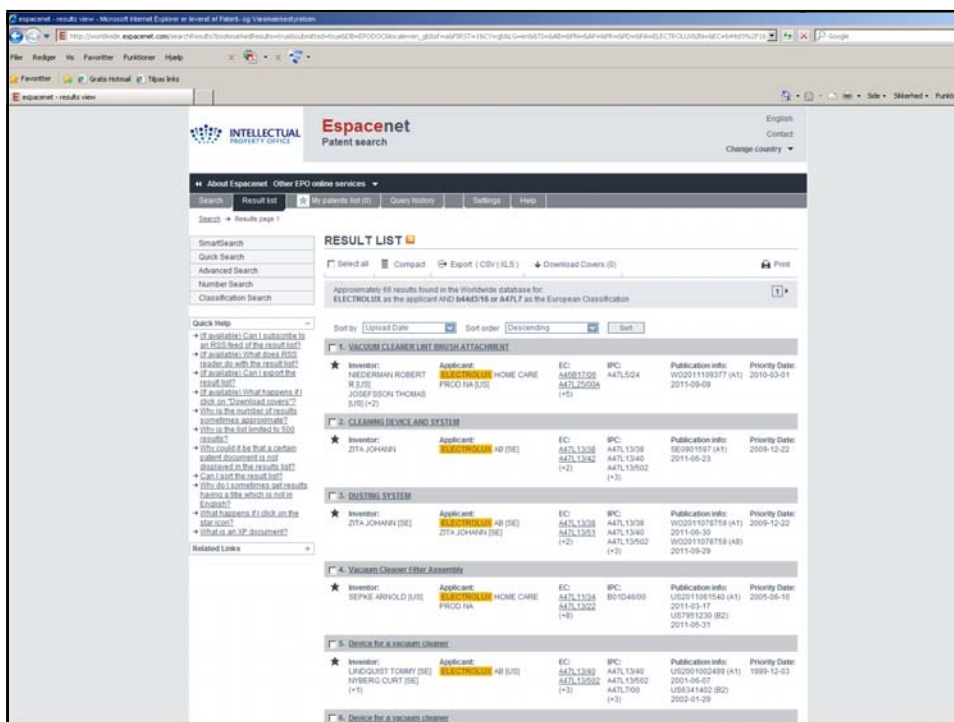
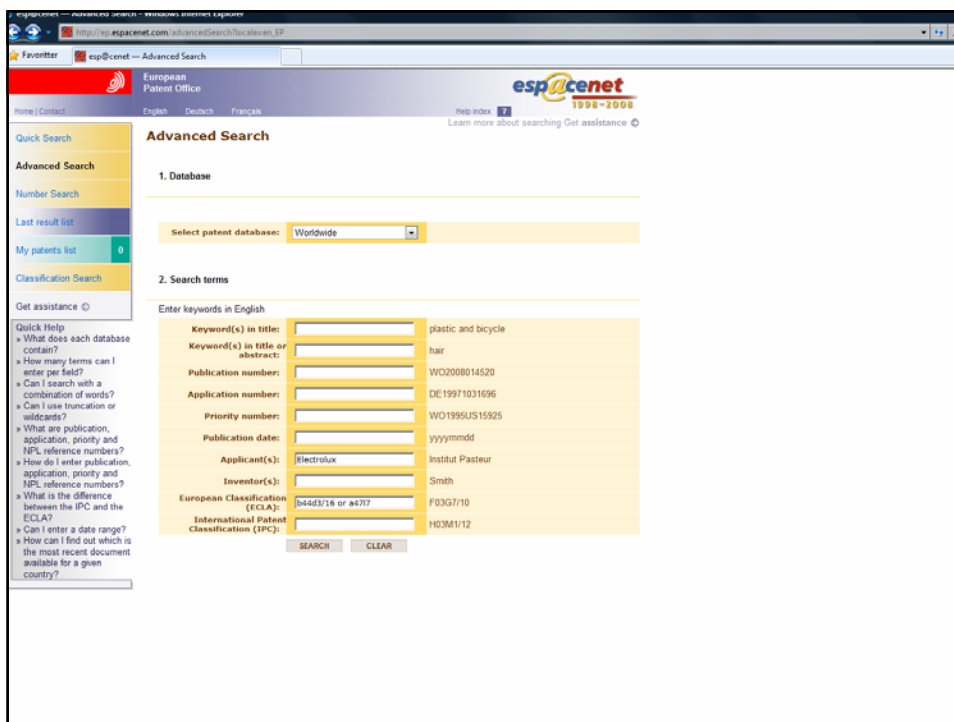

  
**DANISH PATENT AND TRADEMARK OFFICE**

## Questions ????

Anne K. S. Jensen  
[ASJ@dkpto.dk](mailto:ASJ@dkpto.dk)

Tone Kaaber Harrit  
[TKH@dkpto.dk](mailto:TKH@dkpto.dk)

[www.dkpto.dk](http://www.dkpto.dk)



TURNING IDEAS INTO ASSETS®

Ph. D. Patent course 42799 - 2012 25